

PC板间隔柱 SPACER SUPPORT

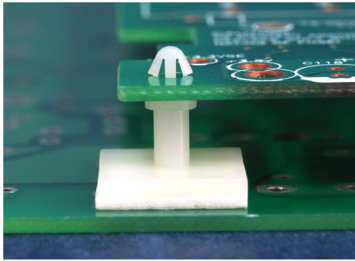

MATERIAL : NYLON 66(UL)
 FLAME CLASS : 94V-0,94V-2
 COLOR : BLACK,NATURAL
 UNIT: mm

用途：背胶式，用于不能钻孔之机板与PC板间之固定

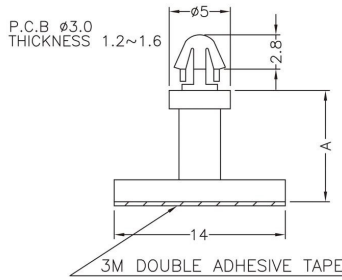
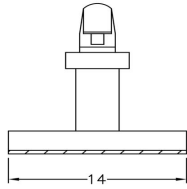

PART NO	A	PACKAGE
PCSS-073	2.7	1000
PCSS-074	4.0	1000
PCSS-075	5.6	1000
PCSS-076	7.2	1000
PCSS-077	9.2	1000
PCSS-1409	9.7	1000
PCSS-078	11.9	1000

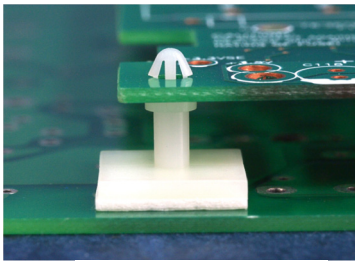

MATERIAL : NYLON 66(UL)
 FLAME CLASS : 94V-0,94V-2
 COLOR : BLACK,NATURAL
 UNIT: mm

用途：背胶式，用于不能钻孔之机板与PC板间之固定
 高度不含背胶及离型纸厚度

6

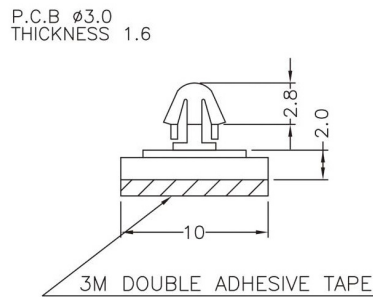
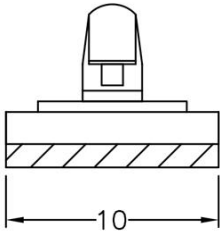

PART NO	PACKAGE
PCSS-079	1000

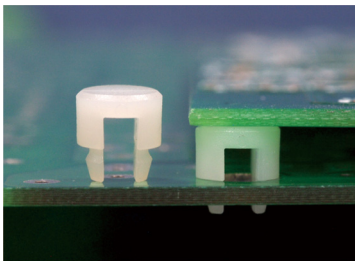

MATERIAL : NYLON 66(UL)
 FLAME CLASS : 94V-0,94V-2
 COLOR : BLACK,NATURAL
 UNIT: mm

用途：直接压入铁板固定

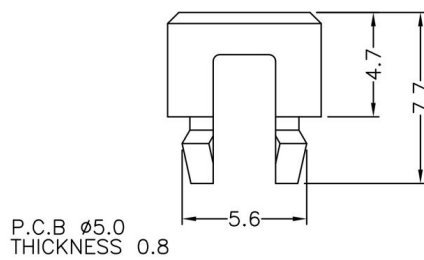
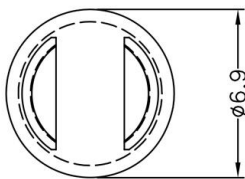

PART NO	PACKAGE
PCSS-080	1000

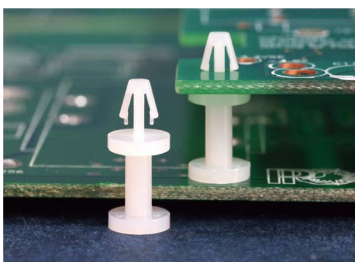

MATERIAL : NYLON 66(UL)
 FLAME CLASS : 94V-0,94V-2
 COLOR : BLACK,NATURAL
 UNIT: mm

用途：支撑PC板，使中间不致震动，载重而凹陷短路。

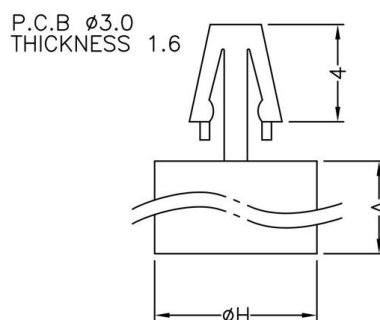

PART NO	A	H	PACKAGE
PCSS-081	2.0	ø6.5	2000
PCSS-082	2.5	ø6.5	2000
PCSS-083	3.0	ø6.8	1000
PCSS-085	4.0	ø6.8	1000
PCSS-084	3.5	ø6.8	1000