

# 电线扎带

CABLE TIE



# 电源线收线带

STRAP TIE



# 粘扣带

VELCRO



电子电脑塑胶五金零件

PLASTIC HARDWARE& ELECTRONIC COMPONENTS

2023 EDITON

电线扎带 电线束线带 固定带 扎线 电源线收线带 珠型扎带 水管座 扎带座 扎带扣  
吊勾 粘扣带 绑线带

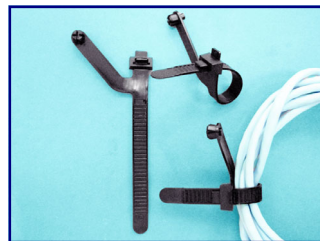
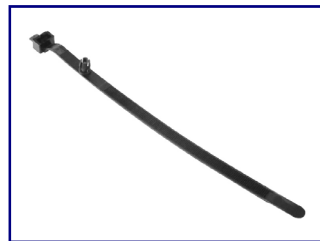
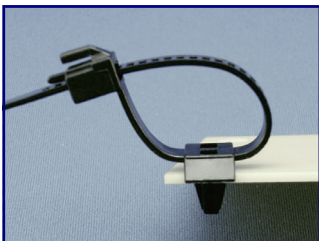
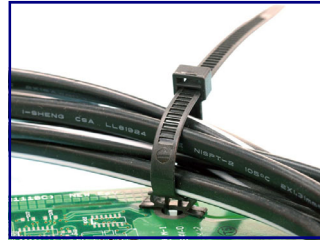
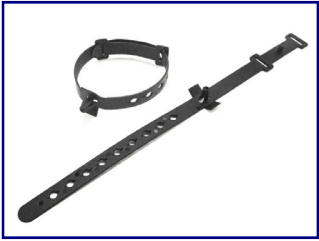
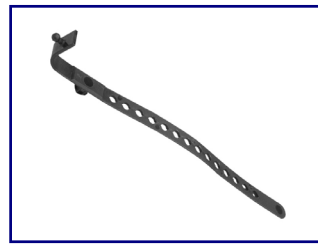
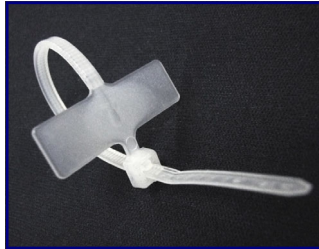
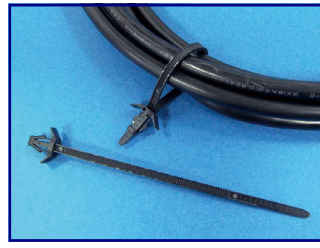
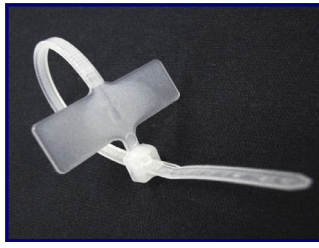
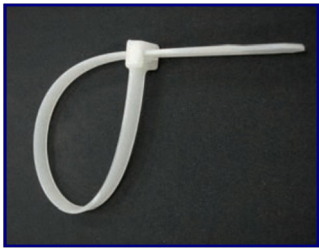
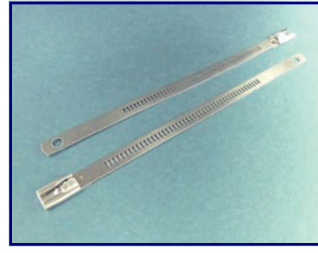
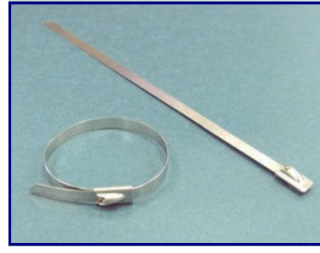
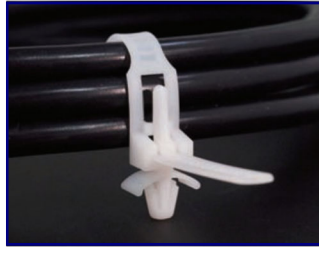
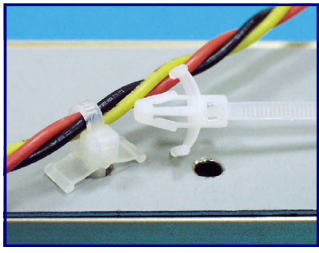

电线扎带 电线束线带 固定带 扎线 电源线收线带 珠型扎带 水管座 扎带座 扎带扣  
吊勾 粘扣带 绑线带

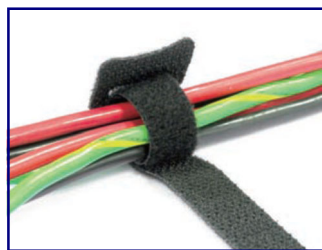
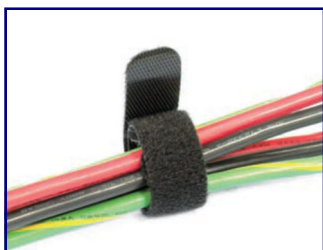
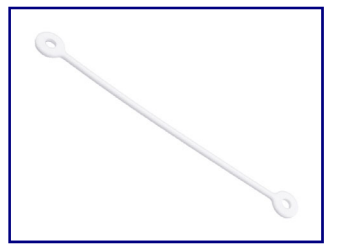
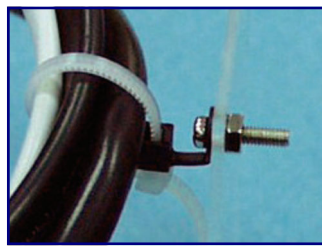
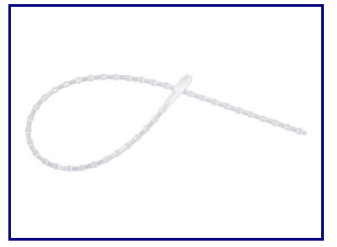
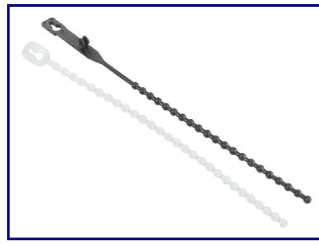
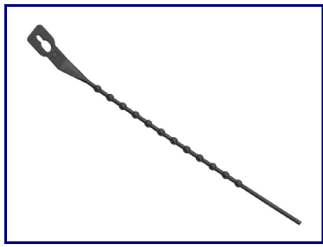
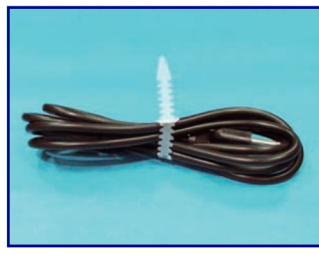
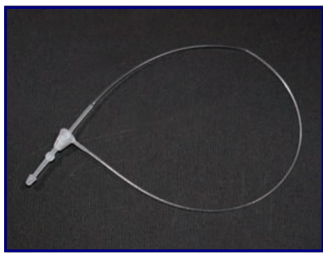



# 电线扎带 CABLE TIE 电线束线带 固定带 扎线

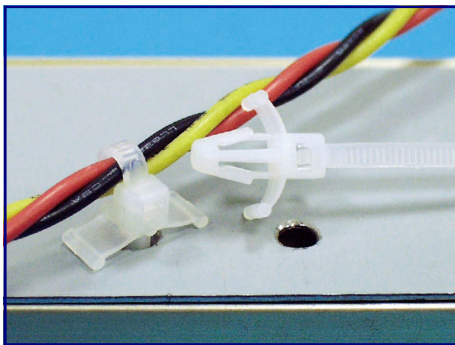

- ◆ MATERIAL : NYLON 66 (UL)
- ◆ FLAME CLASS : 94V-2
- ◆ COLOR : NATURAL/BLACK
- ◆ UNIT: mm

用途： 电线扎带，捆扎电线、物品。

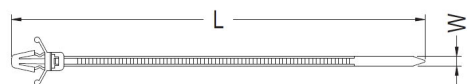

DYS-001 / DYS-006 / DYS-007 / DYS-002

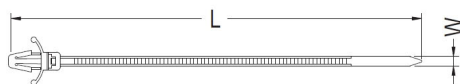

DYS-003

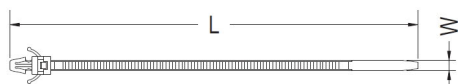

DYS-004

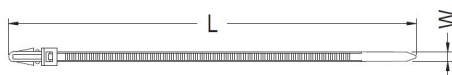

DYS-005 / DYS-008

PART NO	APPROX. LENGTH	APPROX. WITH	MAX BUNDKLE	MIN. LOOP	HOLE	MAX. PANEL	PACK-
	MM(IN)	MM(IN)					
	L	W	MM(IN)	TENSILE	DIAMETER	MM(IN)	
				STRENGTH	CHASIS		
				KGS.(LBS)	MM(IN)		
DYS-001	132(5.12")	4.8(0.19")	25(0.98")	22.2(50)	6.4(0.252")	3.2(0.126")	1000
DYS-002	110(4.33")	2.5(0.10")	22(0.87")	8.1(18)	4.8~5.0 (0.189")~(0.197")	0.8~2.4 (0.03")~(0.09")	1000
DYS-003	110(4.33")	2.5(0.10")	22(0.87")	8.1(18)	4.8~5.0 (0.189")~(0.197")	0.8~2.4 (0.03")~(0.09")	1000
DYS-004	130(5.12")	3.2(0.13")	28(1.10")	13.6(30)	4.0(0.157")	1.0~2.0	1000
DYS-005	150(5.91")	3.6(0.14")	32(1.26")	13.6(30)	5.2(0.205")	1.0~2.8	1000
DYS-006	175(6.69")	4.8(0.19")	38(1.50")	22.2(50)	6.4(0.252")	3.2(0.126")	1000
DYS-007	200(7.68")	4.8(0.19")	45(1.77")	22.2(50)	6.4(0.252")	3.2(0.126")	1000
DYS-008	200(7.87")	4.8(0.19")	46(1.81")	22.2(50)	6.3(0.248")	3.6(0.141")	1000

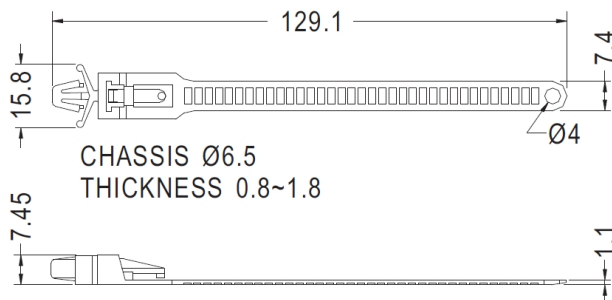

PART NO	PACKAGE
DYS-010	250



# 电线扎带 CABLE TIE 电线束线带 固定带 扎线

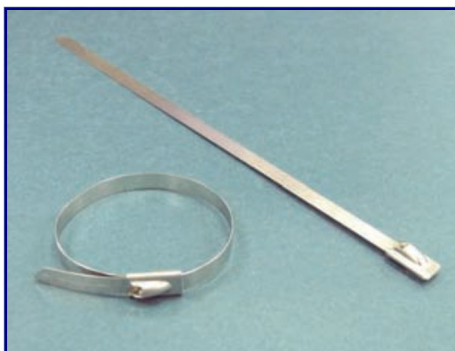

◆ MATERIAL : SUS

用途： 电线扎带，捆扎电线、物品。

◆ UNIT: mm

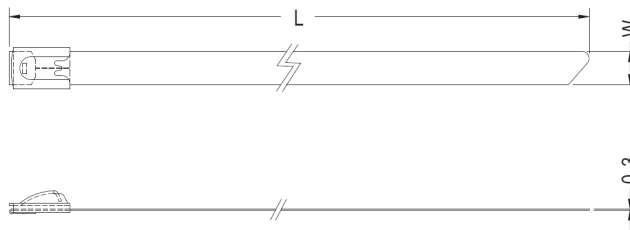

Self-Locking Tie

PART NO	APPROX. LENTH MM(IN)	APPROX. WITH MM(IN)	MAX BUNDKLE MM(IN)	MIN. LOOP TENSILE STRENGTH KGS.(LBS)	PACK- AGE
	L	W			
DYS-011	152(6.00")	4.5(0.177")	25(1.00")	45.3(100)	100
DYS-012	200(8.00")	4.5(0.177")	50(2.00")	45.3(100)	100
DYS-013	360(14.0")	4.5(0.177")	102(4.00")	45.3(100)	100
DYS-014	520(20.0")	4.5(0.177")	152(6.00")	45.3(100)	100
DYS-015	680(27.0")	4.5(0.177")	203(8.00")	45.3(100)	100
DYS-016	840(33.0")	4.5(0.177")	254(10.0")	45.3(100)	100
DYS-017	1050(41.0")	4.5(0.177")	318(12.5")	45.3(100)	50

PART NO	APPROX. LENTH MM(IN)	APPROX. WITH MM(IN)	MAX BUNDKLE MM(IN)	MIN. LOOP TENSILE STRENGTH KGS.(LBS)	PACK- AGE
	L	W			
DYS-018	152(6.00")	8.0(0.315")	25(1.00")	113.3(250)	100
DYS-019	200(8.00")	8.0(0.315")	50(2.00")	113.3(250)	100
DYS-020	360(14.0")	8.0(0.315")	102(4.00")	113.3(250)	100
DYS-021	520(20.0")	8.0(0.315")	152(6.00")	113.3(250)	100
DYS-022	680(27.0")	8.0(0.315")	203(8.00")	113.3(250)	100
DYS-023	840(33.0")	8.0(0.315")	254(10.0")	113.3(250)	100
DYS-024	1050(41.0")	8.0(0.315")	318(12.5")	113.3(250)	50

PART NO	APPROX. LENTH MM(IN)	APPROX. WITH MM(IN)	MAX BUNDKLE MM(IN)	MIN. LOOP TENSILE STRENGTH KGS.(LBS)	PACK- AGE
	L	W			
DYS-025	290(11.0")	12.0(0.472")	80(3.10")	272.0(600)	50
DYS-026	360(14.0")	12.0(0.472")	102(4.00")	272.0(600)	50
DYS-027	430(17.0")	12.0(0.472")	121(4.70")	272.0(600)	50
DYS-028	520(20.0")	12.0(0.472")	152(6.00")	272.0(600)	50
DYS-029	600(24.0")	12.0(0.472")	175(6.80")	272.0(600)	50
DYS-030	680(27.0")	12.0(0.472")	203(8.00")	272.0(600)	50
DYS-031	750(30.0")	12.0(0.472")	230(8.70")	272.0(600)	50
DYS-032	840(33.0")	12.0(0.472")	254(10.0")	272.0(600)	50
DYS-033	910(36.0")	12.0(0.472")	273(10.7")	272.0(600)	25
DYS-034	1000(39.0")	12.0(0.472")	302(11.9")	272.0(600)	25
DYS-035	1070(42.0")	12.0(0.472")	325(12.8")	272.0(600)	25
DYS-036	1200(47.0")	12.0(0.472")	351(13.8")	272.0(600)	25

# 电线扎带 CABLE TIE 电线束线带 固定带 扎线

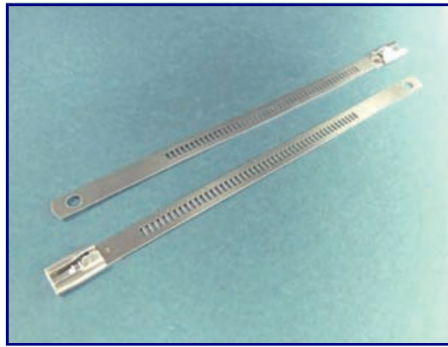

- ◆ MATERIAL : SUS
- ◆ UNIT: mm

用途： 电线扎带，捆扎电线、物品。

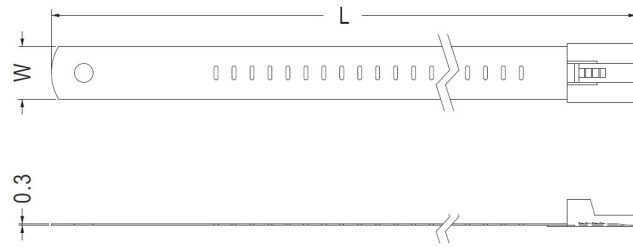

## Self-Locking Tie

PART NO	APPROX. LENTH	APPROX. WITH	MAX BUNDKLE	MIN. LOOP TENSILE STRENGTH	PACK-AGE
	MM(IN)	MM(IN)			
	L	W			
DYS-043	150(5.90")	7.0(0.28")	22(0.86")	113.4(250)	100
DYS-044	195(8.00")	7.0(0.28")	45(1.70")	113.4(250)	100
DYS-045	255(10.0")	7.0(0.28")	64(2.50")	113.4(250)	100
DYS-046	335(13.0")	7.0(0.28")	89(3.50")	113.4(250)	100
DYS-047	490(19.0")	7.0(0.28")	139(5.40")	113.4(250)	100
DYS-048	635(25.0")	7.0(0.28")	185(7.20")	113.4(250)	100

PART NO	APPROX. LENTH	APPROX. WITH	MAX BUNDKLE	MIN. LOOP TENSILE STRENGTH	PACK-AGE
	MM(IN)	MM(IN)			
	L	W			
DYS-049	150(5.90")	12.0(0.472")	22(0.86")	113.4(250)	100
DYS-050	195(8.00")	12.0(0.472")	45(1.70")	113.4(250)	100
DYS-051	255(10.0")	12.0(0.472")	64(2.50")	113.4(250)	100
DYS-052	335(13.0")	12.0(0.472")	89(3.50")	113.4(250)	100
DYS-053	490(19.0")	12.0(0.472")	139(5.40")	113.4(250)	100
DYS-054	635(25.0")	12.0(0.472")	185(7.20")	113.4(250)	100

# 电线扎带 CABLE TIE 电线束线带 固定带 扎线



Clamp Mounting Tie

- ◆ MATERIAL : NYLON 66 (UL)      用途： 电线扎带，捆扎电线、物品。
- ◆ FLAME CLASS : 94V-2/94V-0
- ◆ COLOR : NATURAL/BLACK
- ◆ UNIT: mm

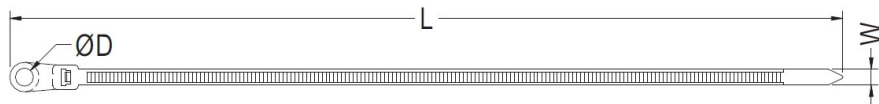

PART NO	D	APPROX. LENTH	APPROX. WITH	MAX BUNDKLE	MIN. LOOP TENSILE STRENGTH	PACKAGE
		MM(IN)	MM(IN)			
		L	W	MM(IN)	KGS.(LBS)	
DYS-055	3.2	110(4.33")	2.8(0.11")	23(0.91")	10(22)	500
DYS-056	4.2	156(6.14")	3.6(0.14")	35(1.38")	18(40)	1000
DYS-057	5.4	205(8.00")	4.8(0.19")	51(2.01")	23(50)	1000
DYS-058	6.4	230(9.00")	7.6(0.30")	58(2.28")	54(120)	100
DYS-059	5.4	255(10.00")	4.8(0.19")	67(2.64")	23(50)	1000
DYS-060	5.4	304(12.00")	4.8(0.19")	83(3.27")	23(50)	500
DYS-061	6.4	306(12.00")	7.6(0.30")	84(3.31")	54(120)	100
DYS-062	5.4	356(14.00")	4.8(0.19")	101(3.98")	23(50)	500
DYS-063	6.4	381(15.00")	7.6(0.30")	108(4.25")	54(120)	100
DYS-064	5.4	406(16.00")	4.8(0.19")	118(4.64")	23(50)	500
DYS-065	6.4	460(18.00")	7.6(0.30")	133(5.24")	54(120)	100
DYS-066	6.4	535(21.00")	7.6(0.30")	155(6.10")	54(120)	100



Push Self-Locking Tie

- ◆ MATERIAL : NYLON 66 (UL)      用途： 电线扎带，捆扎电线、物品。
- ◆ FLAME CLASS : 94V-2
- ◆ COLOR : NATURAL/BLACK
- ◆ UNIT: mm

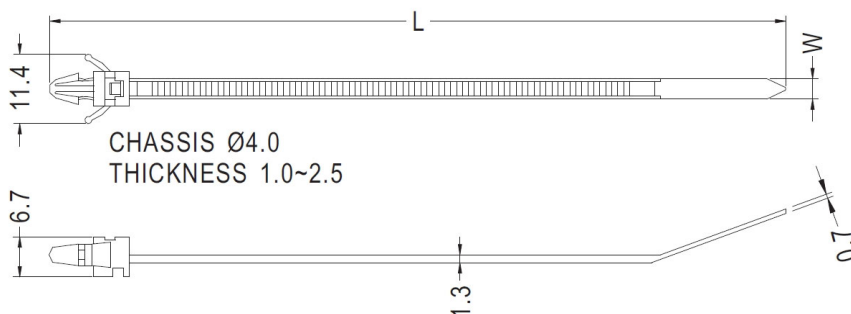

PART NO	APPROX. LENTH	APPROX. WITH	MAX BUNDKLE	MIN. LOOP TENSILE STRENGTH	PACKAGE
	MM(IN)	MM(IN)			
	L	W	MM(IN)	KGS.(LBS)	
DYS-067	123(4.84")	3.4(0.13")	25.4(1.00")	18(40)	1000



# 电线扎带 CABLE TIE 电线束线带 固定带 扎线



- ◆ MATERIAL : NYLON 66 (UL)      用途: 电线扎带, 捆扎电线、物品。
- ◆ FLAME CLASS : 94V-2
- ◆ COLOR : NATURAL/BLACK
- ◆ UNIT: mm

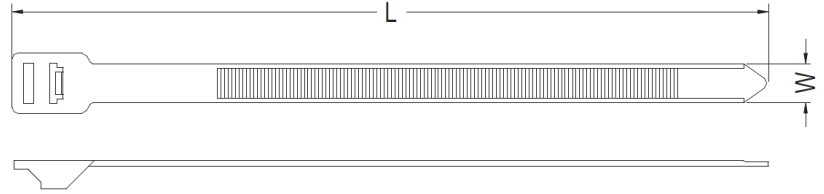

Self-Locking Tie

PART NO	APPROX. LENTH	APPROX. WITH	MAX BUNDKLE	MIN. LOOP TENSILE STRENGTH	PACK-AGE
	MM(IN)	MM(IN)			
	L	W	MM(IN)	KGS.(LBS)	
DYS-074	228(9.00")	12.7(0.50")	54(2.12")	114(250)	100
DYS-075	256(10.00")	12.7(0.50")	62(2.44")	114(250)	100
DYS-076	279(11.00")	12.7(0.50")	70(2.75")	114(250)	100
DYS-077	305(12.00")	12.7(0.50")	78(3.07")	114(250)	100
DYS-078	328(13.00")	12.7(0.50")	86(3.38")	114(250)	100
DYS-079	355(14.00")	12.7(0.50")	94(3.70")	114(250)	100
DYS-080	380(15.00")	12.7(0.50")	102(4.00")	114(250)	100
DYS-081	405(16.00")	12.7(0.50")	110(4.33")	114(250)	100
DYS-082	430(17.00")	12.7(0.50")	118(4.64")	114(250)	100
DYS-083	455(18.00")	12.7(0.50")	127(5.00")	114(250)	100
DYS-084	485(19.00")	12.7(0.50")	135(5.31")	114(250)	100
DYS-085	510(20.00")	12.7(0.50")	143(5.62")	114(250)	100
DYS-086	534(21.00")	12.7(0.50")	151(5.94")	114(250)	100
DYS-087	560(22.00")	12.7(0.50")	159(6.25")	114(250)	100
DYS-088	585(23.00")	12.7(0.50")	167(6.57")	114(250)	100
DYS-089	610(24.00")	12.7(0.50")	175(6.88")	114(250)	100
DYS-090	635(25.00")	12.7(0.50")	183(7.20")	114(250)	100
DYS-091	660(26.00")	12.7(0.50")	191(7.51")	114(250)	100
DYS-092	685(27.00")	12.7(0.50")	199(7.83")	114(250)	100
DYS-093	710(28.00")	12.7(0.50")	207(8.14")	114(250)	100
DYS-094	735(29.00")	12.7(0.50")	215(8.46")	114(250)	100
DYS-095	760(30.00")	12.7(0.50")	224(8.81")	114(250)	100
DYS-096	790(31.00")	12.7(0.50")	232(9.13")	114(250)	100
DYS-097	813(32.00")	12.7(0.50")	243(9.57")	114(250)	100
DYS-098	915(36.00")	12.7(0.50")	274(10.79")	114(250)	100
DYS-099	1042(41.00")	12.7(0.50")	314(12.36")	114(250)	100

# 电线扎带 CABLE TIE 电线束线带 固定带 扎线



- ◆ MATERIAL : NYLON 66 (UL)      用途: 电线扎带, 捆扎电线、物品。
- ◆ FLAME CLASS : 94V-2
- ◆ COLOR : NATURAL/BLACK
- ◆ UNIT: mm

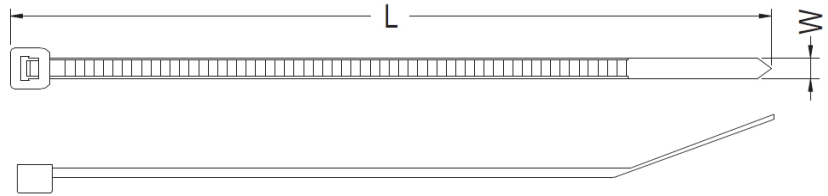

Self-Locking Tie

PART NO	APPROX. LENTH	APPROX. WITH	MAX BUNDKLE	MIN. LOOP TENSILE STRENGTH	PACKAGE
	MM(IN)	MM(IN)			
	L	W	MM(IN)	KGS.(LBS)	
DYS-100	430(16.93")	4.8(0.19")	126(4.96")	23(50)	500
DYS-107	80(3.15")	2.5(0.10")	17(0.67")	8(18)	1000
DYS-109	100(4.00")	2.5(0.10")	23(0.91")	8(18)	1000
DYS-110	102(4.00")	3.6(0.14")	22(0.87")	18(40)	500
DYS-111	115(4.53")	4.8(0.19")	29(1.15")	23(50)	500
DYS-112	120(4.72")	2.5(0.10")	30(1.18")	8(18)	1000
DYS-113	122(4.80")	3.6(0.14")	29(1.14")	18(40)	500
DYS-114	140(5.50")	4.8(0.19")	34(1.34")	23(50)	500
DYS-115	142(5.59")	2.5(0.10")	36(1.42")	8(18)	1000
DYS-116	148(5.83")	7.6(0.30")	36(1.42")	54(120)	100
DYS-117	160(6.30")	2.5(0.10")	42(1.66")	8(18)	1000
DYS-118	162(6.38")	4.8(0.19")	42(1.66")	23(50)	500
DYS-119	163(6.41")	3.6(0.14")	40(1.57")	18(40)	500
DYS-120	178(7.00")	9.0(0.35")	45(1.76")	80(175)	100
DYS-121	181(7.13")	2.5(0.10")	49(1.92")	8(18)	100
DYS-122	182(7.17")	7.6(0.30")	46(1.81")	54(120)	100
DYS-123	185(7.28")	3.6(0.14")	47(1.85")	18(40)	500
DYS-124	188(7.40")	4.8(0.19")	49(1.93")	23(50)	500
DYS-125	201(8.00")	4.8(0.19")	53(2.08")	23(50)	500
DYS-126	203(8.00")	2.5(0.10")	56(2.21")	8(18)	1000
DYS-127	203(8.00")	3.6(0.14")	55(2.17")	18(40)	500
DYS-128	215(8.46")	7.6(0.30")	59(2.32")	54(120)	100
DYS-129	216(8.50")	4.8(0.19")	58(2.28")	23(50)	500
DYS-130	229(9.00")	9.0(0.35")	61(2.40")	80(175)	100
DYS-131	232(9.13")	3.6(0.14")	63(2.48")	18(40)	500
DYS-132	242(9.53")	4.8(0.19")	66(2.60")	23(50)	500
DYS-133	254(10.00")	7.6(0.30")	71(2.80")	54(120)	100
DYS-134	263(10.35")	3.6(0.14")	73(2.87")	18(40)	500
DYS-135	266(10.47")	4.8(0.19")	72(2.84")	23(50)	500

# 电线扎带 CABLE TIE 电线束线带 固定带 扎线



- ◆ MATERIAL : NYLON 66 (UL)      用途: 电线扎带, 捆扎电线、物品。
- ◆ FLAME CLASS : 94V-2
- ◆ COLOR : NATURAL/BLACK
- ◆ UNIT: mm

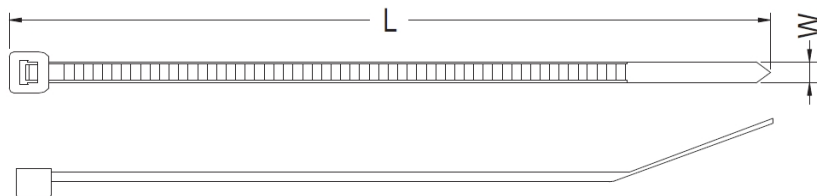

Self-Locking Tie

PART NO	APPROX. LENTH	APPROX. WITH	MAX BUNDKLE	MIN. LOOP TENSILE STRENGTH	PACK-AGE
	MM(IN)	MM(IN)			
	L	W	MM(IN)	KGS.(LBS)	
DYS-136	280(11.00")	9.0(0.35")	77(3.03")	80(175)	100
DYS-137	292(11.50")	4.8(0.19")	82(3.23")	23(50)	500
DYS-138	293(11.54")	7.6(0.30")	84(3.30")	54(120)	100
DYS-139	295(11.61")	3.6(0.14")	83(3.27")	18(40)	500
DYS-140	329(13.00")	9.0(0.35")	93(3.66")	80(175)	100
DYS-141	330(13.00")	4.8(0.19")	93(3.66")	23(50)	500
DYS-142	331(13.00")	3.6(0.14")	96(3.78")	18(40)	500
DYS-143	332(13.00")	7.6(0.30")	95(3.74")	54(120)	100
DYS-144	368(14.49")	4.8(0.19")	106(4.17")	23(50)	500
DYS-145	368(14.49")	7.6(0.30")	109(4.29")	54(120)	100
DYS-147	382(15.00")	9.0(0.35")	110(4.33")	80(175)	100
DYS-148	410(16.14")	4.8(0.19")	122(4.80")	23(50)	500
DYS-149	420(16.54")	7.6(0.30")	124(4.88")	54(120)	100
DYS-150	450(17.72")	4.8(0.19")	135(5.31")	23(50)	100
DYS-151	458(18.00")	9.0(0.35")	135(5.32")	80(175)	100
DYS-152	470(18.50")	7.6(0.30")	140(5.51")	54(120)	100
DYS-153	520(20.47")	7.6(0.30")	156(6.14")	54(120)	100
DYS-154	530(20.87")	9.0(0.35")	155(6.10")	80(175)	100
DYS-155	655(25.79")	9.0(0.35")	194(7.64")	80(175)	100
DYS-156	780(30.71")	9.0(0.35")	234(9.21")	80(175)	100
DYS-157	815(32.00")	9.0(0.35")	247(9.72")	80(175)	100
DYS-158	142(5.59")	3.6(0.14")	34(1.34")	18(40)	1000
DYS-194	370(14.57")	3.6(0.14")	108(4.25")	18(40)	500



电线扎带 CABLE TIE 电线束线带 固定带 扎线

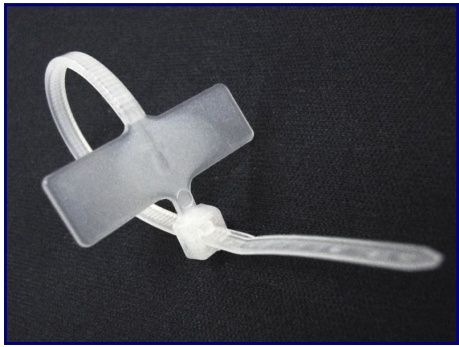

Marker Tie

- ◆ MATERIAL : NYLON 66 (UL)      用途: 电线扎带, 捆扎电线、物品。
- ◆ FLAME CLASS : 94V-2
- ◆ COLOR : NATURAL/BLACK
- ◆ UNIT: mm

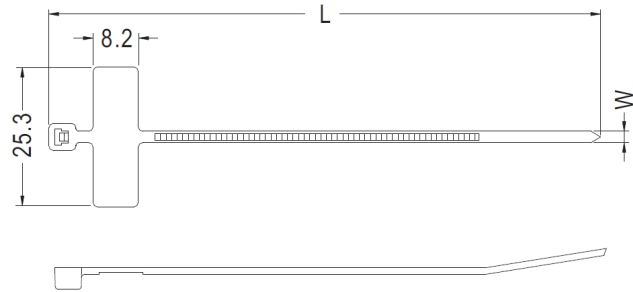

PART NO	APPROX. LENTH	APPROX. WITH	MAX BUNDKLE	MIN. LOOP TENSILE STRENGTH	PACKAGE
	MM(IN)	MM(IN)			
	L	W	MM(IN)	KGS.(LBS)	
DYS-159	100(4.00")	2.5(0.10")	22(0.87")	8(18)	500

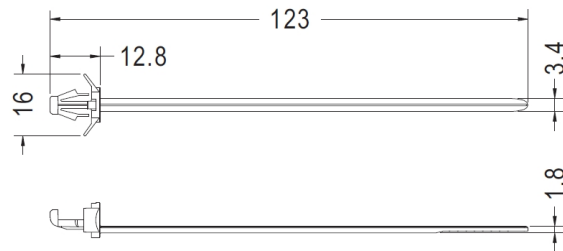

MOUNTING HOLE Ø5.4  
THICKNESS 2.0~3.2

PART NO	PACKAGE
DYS-146	500

# 电线扎带 (可重复使用) RELEASABLE CABLE TIE 电线束线带 固定带 扎线



- ◆ MATERIAL : NYLON 66 (UL)
- ◆ FLAME CLASS : 94V-2
- ◆ COLOR : NATURAL/BLACK
- ◆ UNIT: mm

用途: 电线扎带, 捆扎电线、物品, 此系列为可重复性使用。

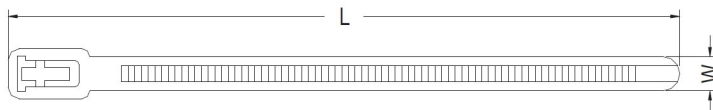

Releasable Tie



PART NO	APPROX. LENTH	APPROX. WITH	MAX BUNDKLE	MIN. LOOP TENSILE STRENGTH	PACK-AGE
	MM(IN)	MM(IN)			
	L	W	MM(IN)	KGS.(LBS)	
DYS-101	150(5.90")	7.5(0.295")	39(1.54")	23(50)	100
DYS-102	200(7.87")	7.5(0.295")	56(2.21")	23(50)	100
DYS-103	250(9.84")	7.5(0.295")	72(2.83")	23(50)	100

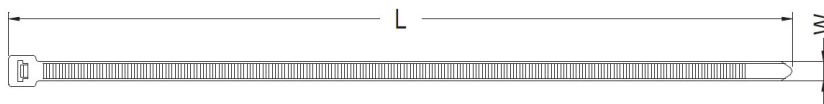

Releasable Tie

PART NO	APPROX. LENTH	APPROX. WITH	MAX BUNDKLE	MIN. LOOP TENSILE STRENGTH	PACK-AGE
	MM(IN)	MM(IN)			
	L	W	MM(IN)	KGS.(LBS)	
DYS-104	655(25.79")	9.0(0.35")	194(7.64")	80(175)	100
DYS-105	780(30.71")	9.0(0.35")	234(9.21")	80(175)	100
DYS-106	815(32.00")	9.0(0.35")	247(9.72")	80(175)	100
DYS-189	300(11.81")	7.6(0.30")	86(3.38")	23(50)	100
DYS-190	350(13.87")	7.6(0.30")	102(4.02")	23(50)	100
DYS-191	400(15.75")	7.6(0.30")	118(4.65")	23(50)	100

**电线扎带 (可重复使用) RELEASABLE CABLE TIE 电线束线带 固定带 扎线**

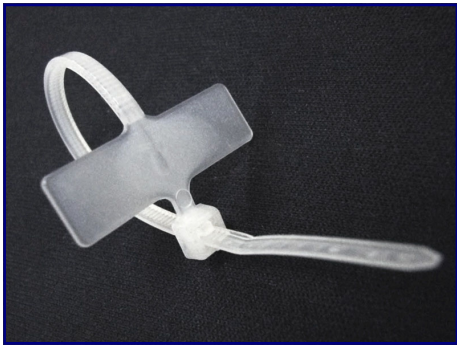

Push Releasable Tie

- ◆ MATERIAL : NYLON 66 (UL)      用途: 电线扎带, 捆扎电线、物品。
- ◆ FLAME CLASS : 94V-2
- ◆ COLOR : NATURAL/BLACK
- ◆ UNIT: mm

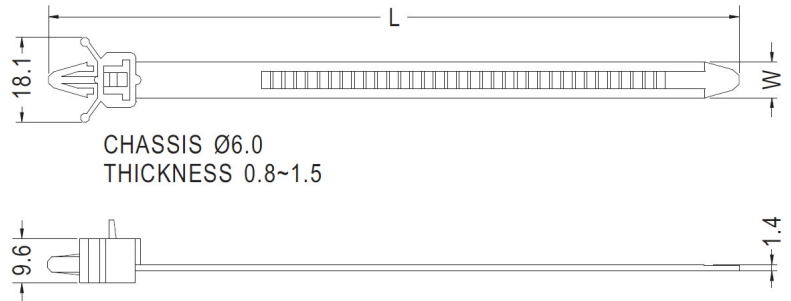

PART NO	APPROX. LENTH	APPROX. WITH	MAX BUNDKLE	MIN. LOOP TENSILE STRENGTH	PACKAGE
	MM(IN)	MM(IN)			
	L	W	MM(IN)	KGS.(LBS)	
DYS-160	151(6.00")	7.8(0.30")	37(1.45")	40(88)	100
DYS-161	191(7.50")	7.8(0.30")	49(1.92")	40(88)	100
DYS-162	231(9.00")	7.8(0.30")	62(2.44")	40(88)	100



# 电线扎带 (可重复使用) RELEASABLE CABLE TIE 电线束线带 固定带 扎线



- ◆ MATERIAL : NYLON 66 (UL)
- ◆ FLAME CLASS : 94V-2
- ◆ COLOR : NATURAL/BLACK
- ◆ UNIT: mm

用途: 电线扎带, 捆扎电线、物品, 此系列为可重复性使用。

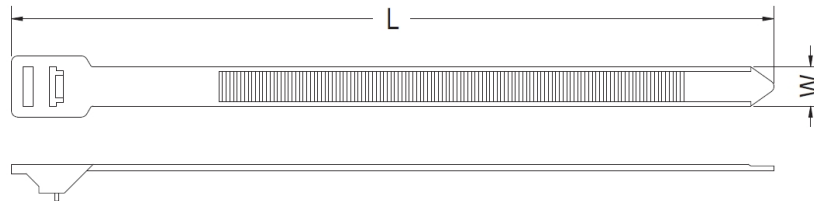

Releasable Tie

PART NO	APPROX. LENTH MM(IN)	APPROX. WITH MM(IN)	MAX BUNDKLE MM(IN)	MIN. LOOP TENSILE STRENGTH KGS.(LBS)	PACK- AGE
	L	W			
DYS-163	790(31.00")	12.7(0.50")	232(9.13")	114(250)	100
DYS-164	813(32.00")	12.7(0.50")	243(9.57")	114(250)	100
DYS-165	915(36.00")	12.7(0.50")	274(10.79")	114(250)	100
DYS-166	1042(41.00")	12.7(0.50")	314(12.36")	114(250)	100
DYS-167	760(30.00")	12.7(0.50")	224(8.81")	114(250)	100
DYS-168	228(9.00")	12.7(0.50")	54(2.12")	114(250)	100
DYS-169	256(10.00")	12.7(0.50")	62(2.44")	114(250)	100
DYS-170	279(11.00")	12.7(0.50")	70(2.75")	114(250)	100
DYS-171	305(12.00")	12.7(0.50")	78(3.07")	114(250)	100
DYS-172	328(13.00")	12.7(0.50")	86(3.38")	114(250)	100
DYS-173	355(14.00")	12.7(0.50")	94(3.70")	114(250)	100
DYS-174	380(15.00")	12.7(0.50")	102(4.00")	114(250)	100
DYS-175	405(16.00")	12.7(0.50")	110(4.33")	114(250)	100
DYS-176	430(17.00")	12.7(0.50")	118(4.64")	114(250)	100
DYS-177	455(18.00")	12.7(0.50")	127(5.00")	114(250)	100
DYS-178	485(19.00")	12.7(0.50")	135(5.31")	114(250)	100
DYS-179	510(20.00")	12.7(0.50")	143(5.62")	114(250)	100
DYS-180	534(21.00")	12.7(0.50")	151(5.94")	114(250)	100
DYS-181	560(22.00")	12.7(0.50")	159(6.25")	114(250)	100
DYS-182	585(23.00")	12.7(0.50")	167(6.57")	114(250)	100
DYS-183	610(24.00")	12.7(0.50")	175(6.88")	114(250)	100
DYS-184	635(25.00")	12.7(0.50")	183(7.20")	114(250)	100
DYS-185	660(26.00")	12.7(0.50")	191(7.51")	114(250)	100
DYS-186	685(27.00")	12.7(0.50")	199(7.83")	114(250)	100
DYS-187	710(28.00")	12.7(0.50")	207(8.14")	114(250)	100
DYS-188	735(29.00")	12.7(0.50")	215(8.46")	114(250)	100

# 电线扎带 CABLE TIE 电线束线带 固定带 扎线



- ◆ MATERIAL : PE
- ◆ COLOR : BLACK
- ◆ UNIT: mm

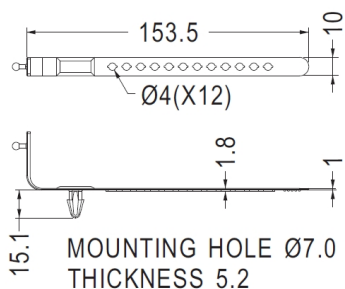

用途： 电线扎带，捆扎电线、物品。

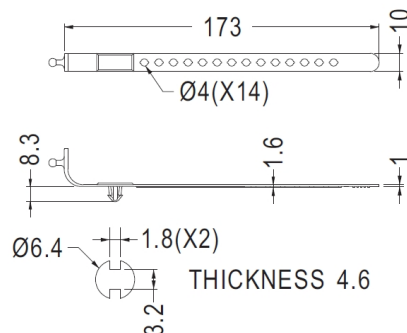

PART NO	PACKAGE
DYS-073	500

PART NO	PACKAGE
DYS-193	500



- ◆ MATERIAL : NYLON 66 (UL)
- ◆ FLAME CLASS : 94V-2/94V-0
- ◆ COLOR : NATURAL/BLACK
- ◆ UNIT: mm

用途： 电线扎带，捆扎电线、物品。

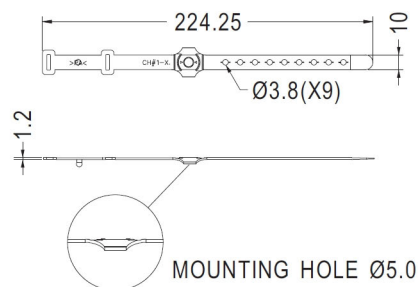
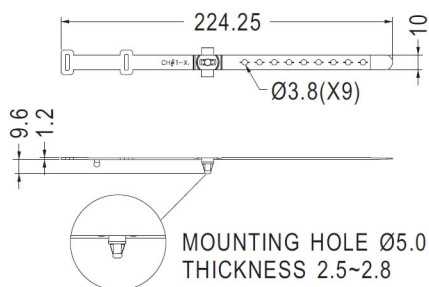

PART NO	PACKAGE
DYS-068	500

PART NO	PACKAGE
DYS-069	500

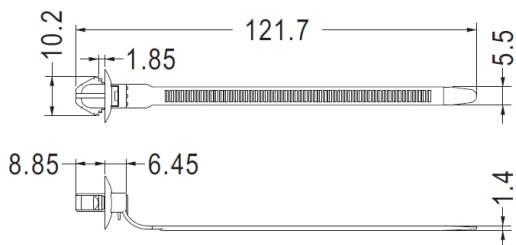

HOLE IN P.C.B Ø8.0 THICKNESS 1.0  
HOLE IN P.C.B Ø10.0 THICKNESS 2.0

PART NO	PACKAGE
DYS-192	1000

# 电线扎带 CABLE TIE 电线束线带 固定带 扎线

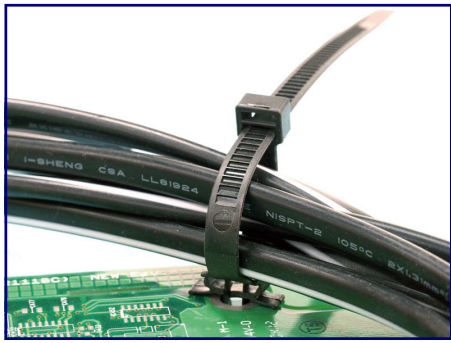

- ◆ MATERIAL : NYLON 66 (UL)      用途: 电线扎带, 捆扎电线、物品。
- ◆ FLAME CLASS : 94V-2/94V-0
- ◆ COLOR : NATURAL/BLACK
- ◆ UNIT: mm

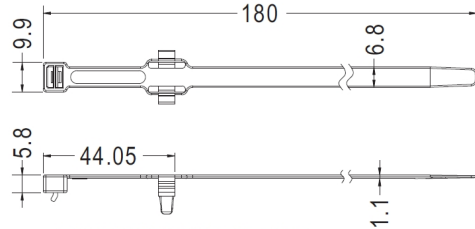

MOUNTING HOLE Ø5.5  
THICKNESS: T

PART NO	T	PACKAGE
DYS-037	0.8~2.0	200
DYS-195	2.3~2.5	200

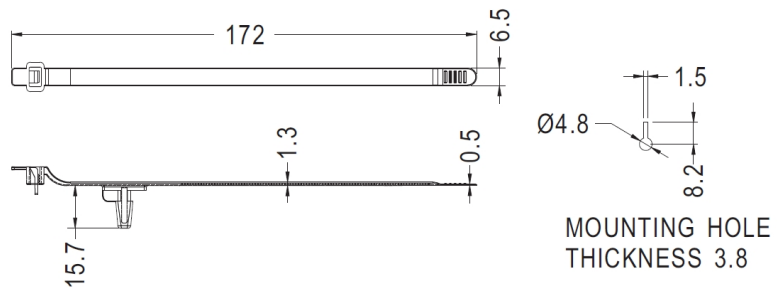

MOUNTING HOLE  
THICKNESS 3.8

PART NO	PACKAGE
DYS-041	200

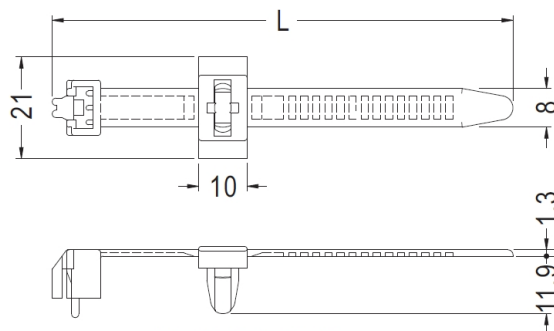
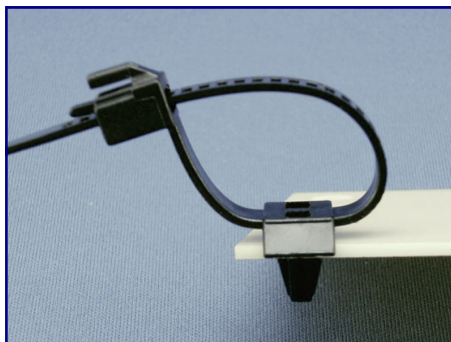

CHASSIS Ø7.0  
THICKNESS 4.0

PART NO	L	PACKAGE
DYS-196	115.3	200
DYS-197	175.0	200

# 电线扎带 CABLE TIE 电线束线带 固定带 扎线

用途： 电线扎带，捆扎电线、物品。

- ◆ MATERIAL : NYLON 66 (UL)
- ◆ FLAME CLASS : 94V-2/94V-0
- ◆ COLOR : NATURAL/BLACK
- ◆ UNIT: mm

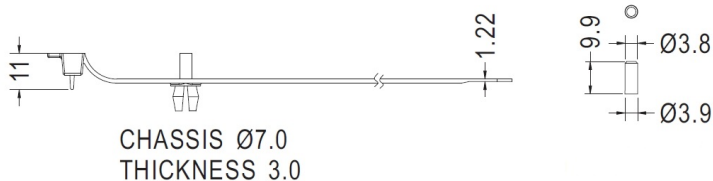

PART NO	PACKAGE
DYS-198	250

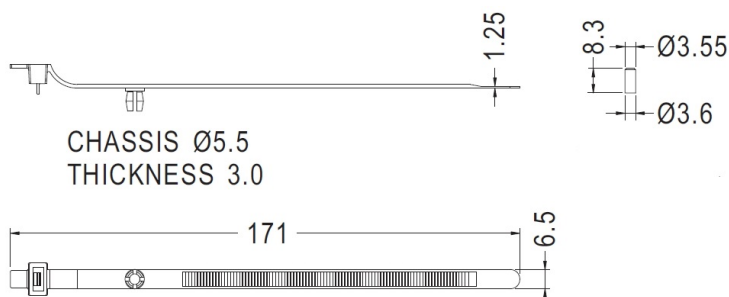

PART NO	PACKAGE
DYS-199	100

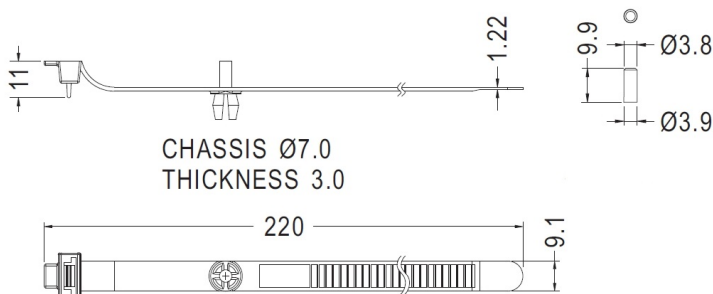

PART NO	PACKAGE
DYS-200	100

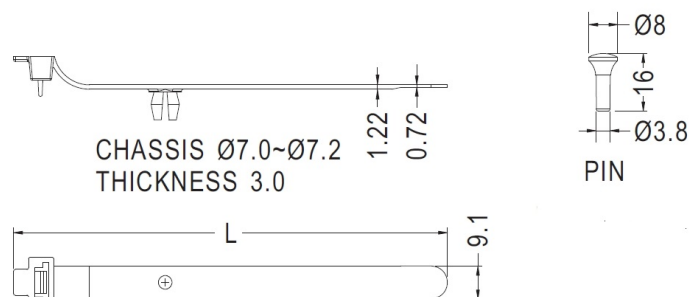

PART NO	L	PACKAGE
DYS-071	121.0	100
DYS-072	171.2	100

# 电线扎带 CABLE TIE 电线束线带 固定带 扎线



- ◆ MATERIAL : NYLON 66 (UL)
- ◆ FLAME CLASS : 94V-2/94V-0
- ◆ COLOR : NATURAL/BLACK
- ◆ UNIT: mm

用途: 电线扎带, 捆扎电线、物品。

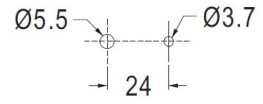
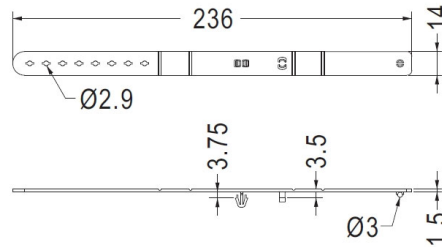

MOUNTING HOLE THICKNESS 2.0~2.5

PART NO	PACKAGE
DYS-070	500

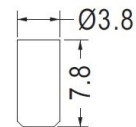
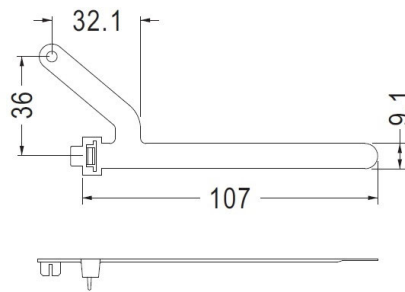

CHASSIS Ø7.0

PART NO	PACKAGE
DYS-042	100



# 电源线收线带 STRAP TIE 电线束线带 固定带 扎线 扎带

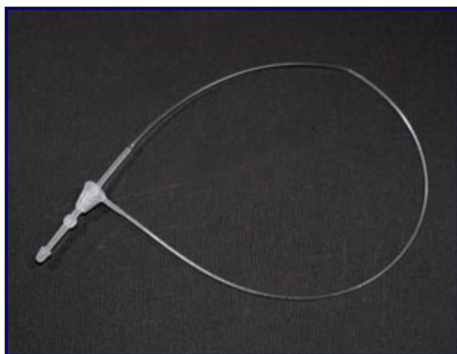

- ◆ MATERIAL : PP
- ◆ COLOR : NATURAL
- ◆ UNIT: mm

用途: 电源线收线带, 捆扎电线、物品。

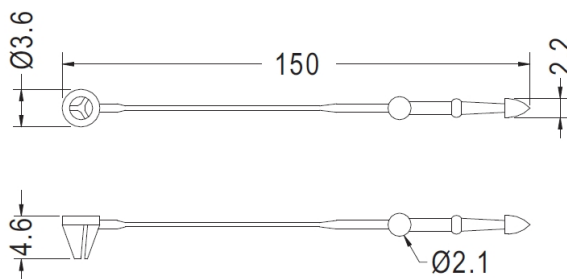

PART NO	PACKAGE
DYS-201	1000

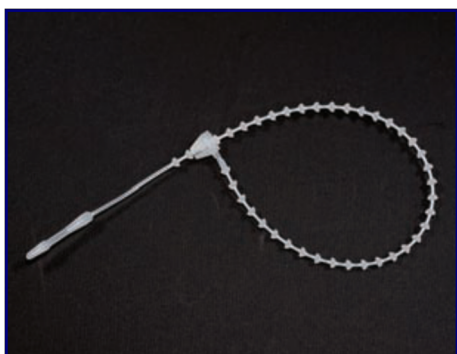

- ◆ MATERIAL : NYLON 66 (UL)
- ◆ FLAME CLASS : 94V-2/94V-0
- ◆ COLOR : NATURAL/BLACK
- ◆ UNIT: mm

- ◆ MATERIAL : PP
- ◆ COLOR : NATURAL
- ◆ UNIT: mm

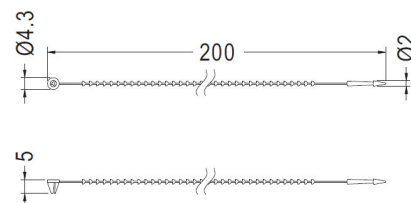
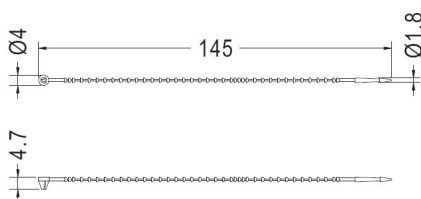

PART NO	PACKAGE
DYS-203	1000

PART NO	PACKAGE
DYS-202	1000



- ◆ MATERIAL : NYLON 66 (UL)/PE
- ◆ FLAME CLASS : 94V-2
- ◆ COLOR : NATURAL/BLACK
- ◆ UNIT: mm

用途: 电源线收线带, 捆扎机器电线, 美观不占空间。

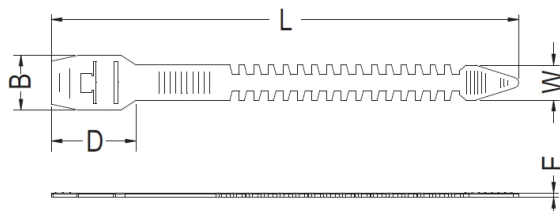

PART NO	B	D	E	L	W	PACKAGE
DYS-204	15.8	21.4	1.2	135.0	10.0	500
DYS-205	15.4	24.5	1.2	140.0	10.0	500

# 电源线收线带 STRAP TIE 电线束线带 固定带 扎线 扎带

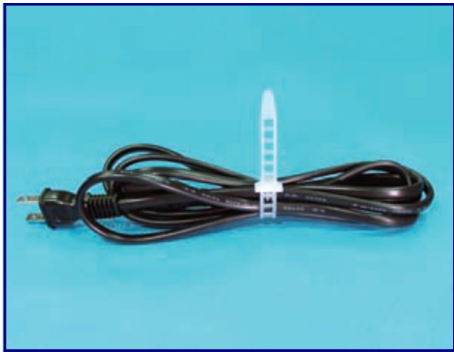

- ◆ MATERIAL : NYLON 66 (UL)/PE      用途: 电源线收线带, 捆扎机器电线, 美观不占空间。
- ◆ FLAME CLASS : 94V-2
- ◆ COLOR : NATURAL/BLACK
- ◆ UNIT: mm

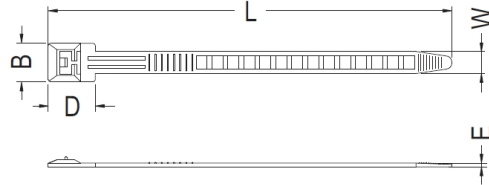

PART NO	B	D	E	L	W	PACKAGE
DYS-206	15.0	18.3	1.0	157.0	8.6	500
DYS-207	15.0	18.3	1.5	157.0	8.6	500
DYS-208	15.0	18.3	1.7	205.0	8.6	500
DYS-209	13.0	16.0	1.45	125.0	7.5	500
DYS-210	13.0	16.0	1.0	125.0	7.5	500
DYS-211	15.0	18.3	1.7	300.0	8.6	500

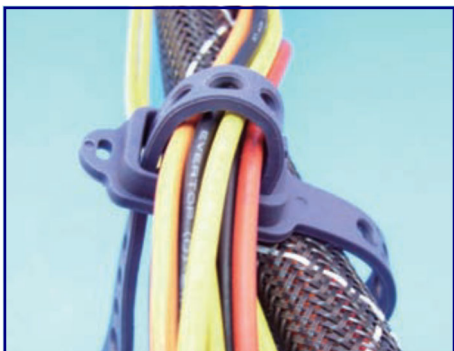

- ◆ MATERIAL : TPE      用途: 电源线收线带, 捆扎电线、物品。
- ◆ COLOR : BLUE/BLACK
- ◆ UNIT: mm

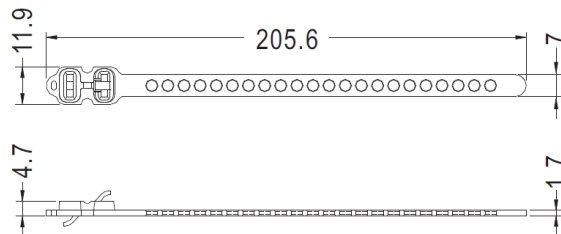

PART NO	PACKAGE
DYS-212	250

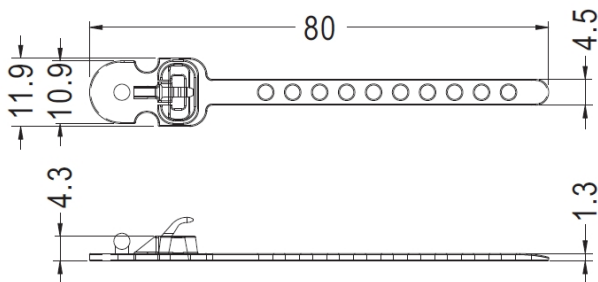

PART NO	PACKAGE
DYS-213	500

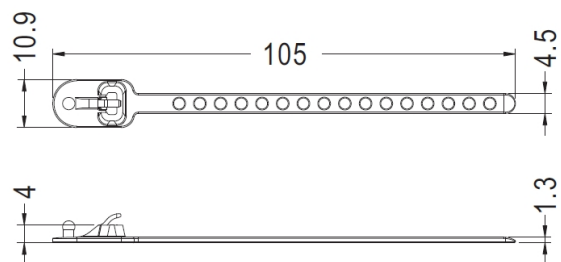

PART NO	PACKAGE
DYS-214	500

# 电源线收线带 STRAP TIE 电线束线带 固定带 扎线 扎带



- ◆ MATERIAL : PE
- ◆ COLOR : NATURAL
- ◆ UNIT: mm

用途: 电源线收线带, 捆扎电线、物品。

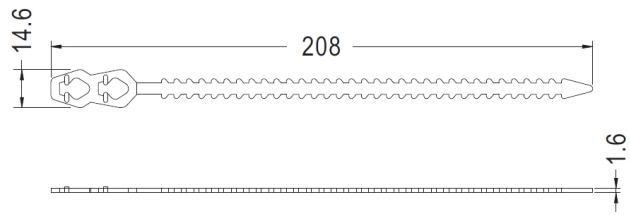

PART NO	PACKAGE
DYS-215	500



- ◆ MATERIAL : PE
- ◆ COLOR : BLACK
- ◆ UNIT: mm

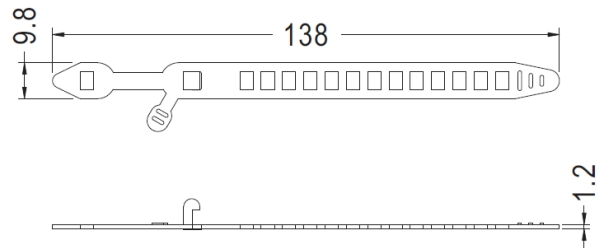

PART NO	PACKAGE
DYS-216	500

# 珠型扎带 STRAP TIE 电线束线带 固定带 扎线 扎带



- ◆ MATERIAL : NYLON 66 (UL)      用途: 电源线收线带 , 捆扎电线、物品。
- ◆ FLAME CLASS : 94V-2/94V-0
- ◆ COLOR : NATURAL/BLACK
- ◆ UNIT: mm

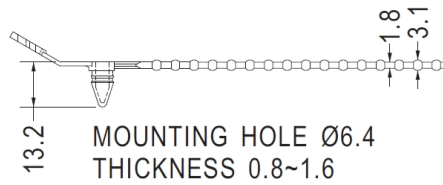
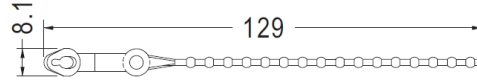

PART NO	PACKAGE
DYS-217	500

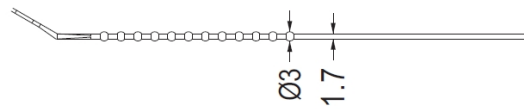
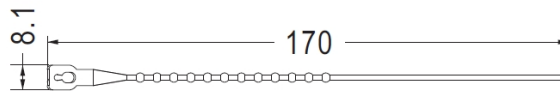
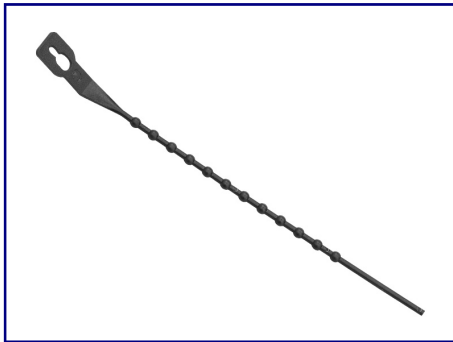

PART NO	PACKAGE
DYS-218	500



- ◆ MATERIAL : PET      用途: 电源线收线带 , 捆扎电线、物品。
- ◆ COLOR : NATURAL
- ◆ UNIT: mm

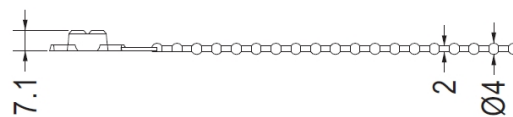
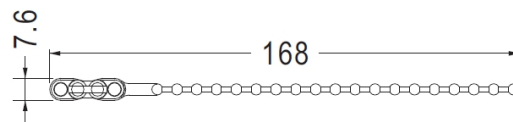

PART NO	PACKAGE
DYS-219	500

# 珠型扎带 STRAP TIE 电线束线带 固定带 扎线 扎带

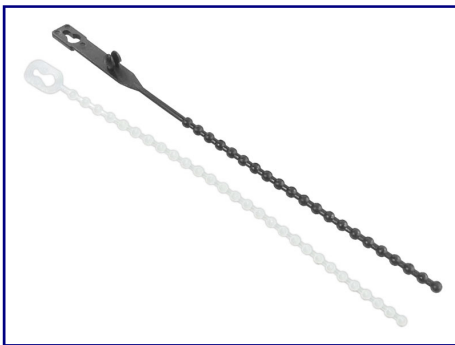

- ◆ MATERIAL : NYLON 66 (UL)
- ◆ FLAME CLASS : 94V-2/94V-0
- ◆ COLOR : NATURAL/BLACK
- ◆ UNIT: mm

用途: 电源线收线带, 捆扎电线、物品。

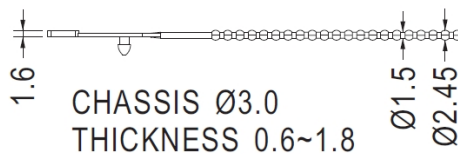
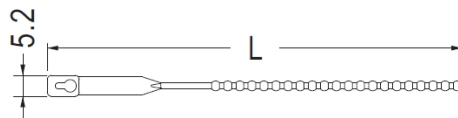
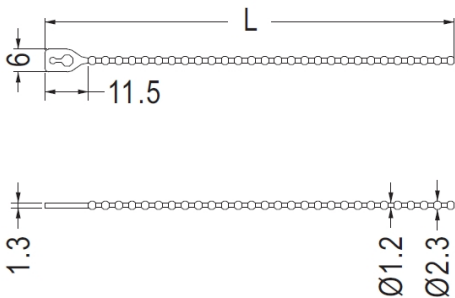

PART NO	L	PACKAGE
DYS-220	70.0	1000
DYS-221	112.0	1000

PART NO	L	PACKAGE
DYS-222	85.0	1000
DYS-223	103.0	1000

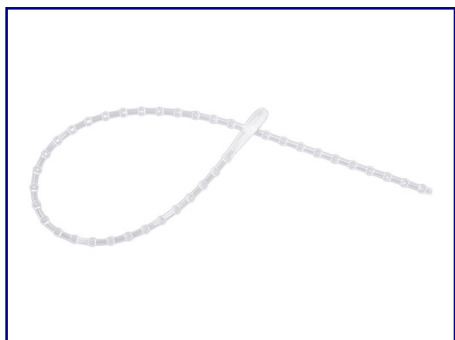

- ◆ MATERIAL : PP
- ◆ COLOR : NATURAL
- ◆ UNIT: mm

用途: 电源线收线带, 捆扎电线、物品。

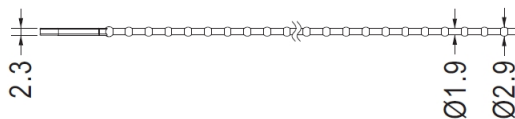
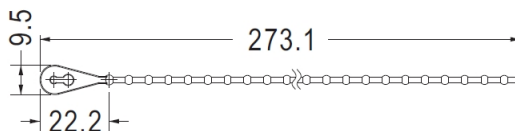

PART NO	PACKAGE
DYS-224	500

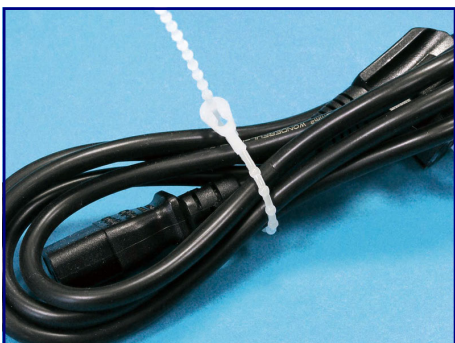

- ◆ MATERIAL : PP
- ◆ FLAME CLASS : 94HB
- ◆ COLOR : NATURAL
- ◆ UNIT: mm

用途: 电源线收线带, 捆扎电线、物品。

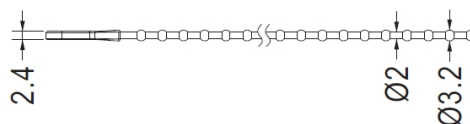
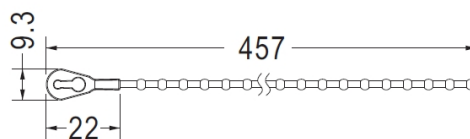

PART NO	PACKAGE
DYS-225	500



## 珠型扎带 STRAP TIE 电线束线带 固定带 扎线 扎带



- ◆ MATERIAL : PP (UL)
- ◆ FLAME CLASS : 94HB
- ◆ COLOR : NATURAL
- ◆ UNIT: mm

用途：电源线收线带，捆扎电线、物品。

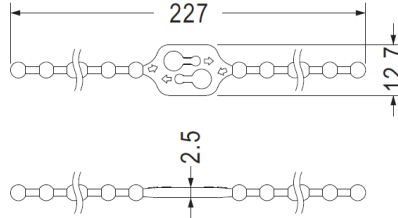

PART NO	PACKAGE
DYS-226	200

## 水管座 PIPE MOUNT



- ◆ MATERIAL : NYLON 66 (UL)
- ◆ FLAME CLASS : 94V-2/94V-0
- ◆ COLOR : BLACK
- ◆ UNIT: mm

用途：水管座，捆扎电线、物品。

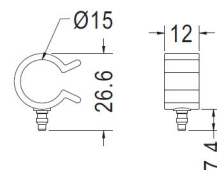
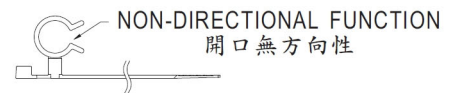
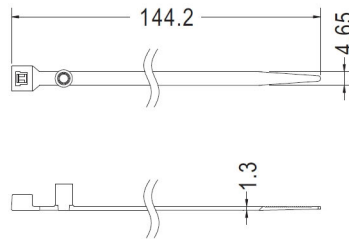

PART NO	PACKAGE
WAT-1	250

# 扎带座 CABLE MOUNT 扎线座 束线座

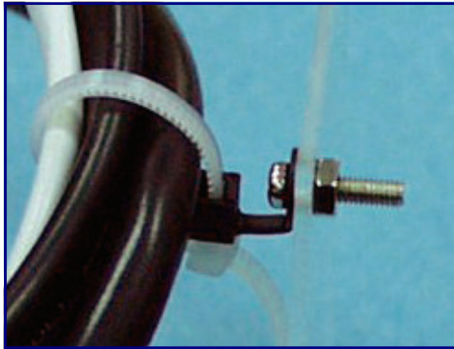

- ◆ MATERIAL : NYLON 66 (UL)
- ◆ FLAME CLASS : 94V-2/94V-0
- ◆ COLOR : NATURAL/BLACK
- ◆ UNIT: mm

用途：扎带座，配合束线带可固定电线于机板上。

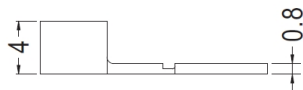
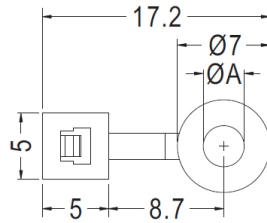

PART NO	L	PACKAGE
ASL-1	2.8	2000
ASL-2	3.1	2000

## 扎带扣 CABLE TIE BUCKLE 扎线扣

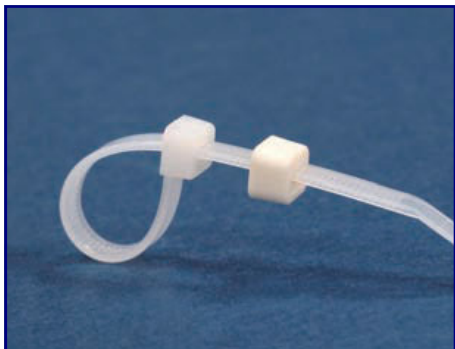

- ◆ MATERIAL : NYLON 66 (UL)
- ◆ FLAME CLASS : 94V-2/94V-0
- ◆ COLOR : BLACK/NATURAL
- ◆ UNIT: mm

用途: 扎带扣 , 捆扎电线、物品。

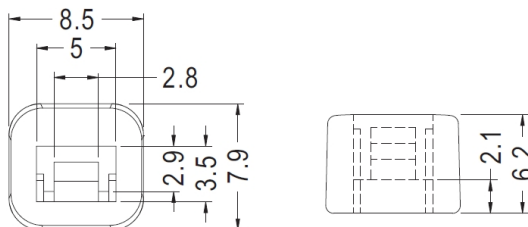

PART NO	PACKAGE
YH01	1000

## 吊勾 HANDLE GRIP

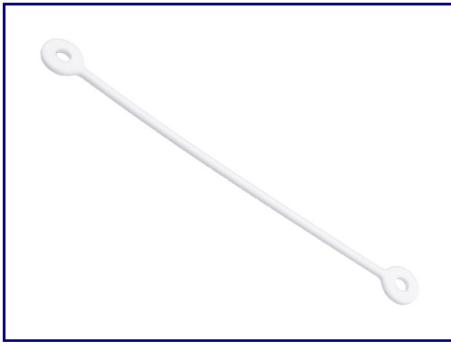

- ◆ MATERIAL : PE
- ◆ COLOR : WHITE/BLACK
- ◆ UNIT: mm

用途：吊勾，用于电线之固定。

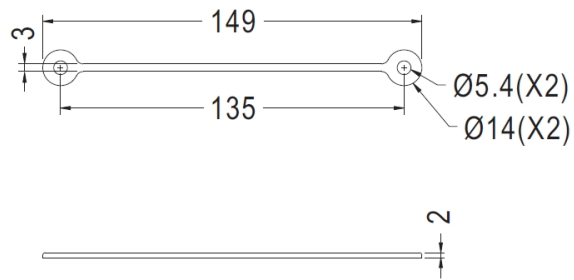

PART NO	PACKAGE
SAK-1	1000

# 粘扣带 VELCRO 绑线带



用途： 粘扣带，捆扎电线、物品。

- ◆ MATERIAL : NYLON
- ◆ COLOR : BLACK
- ◆ UNIT: mm

依不同尺寸，可接受訂製。  
Different size available per request.

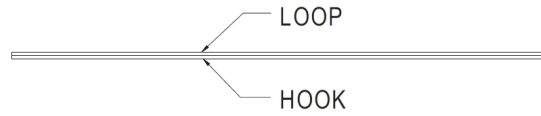
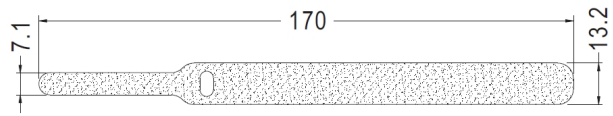
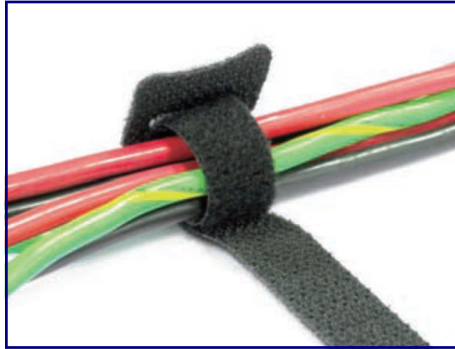

PART NO	PACKAGE
VELCRO-1	500

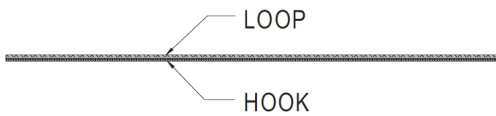
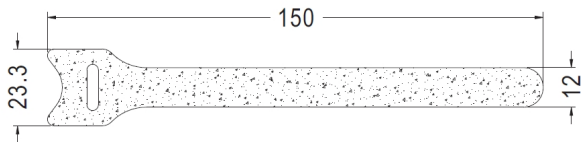

PART NO	PACKAGE
VELCRO-2	500

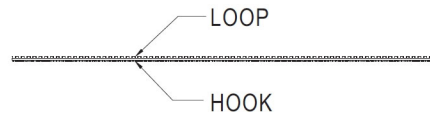
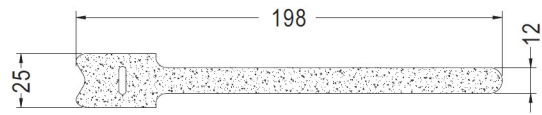

PART NO	PACKAGE
VELCRO-3	500

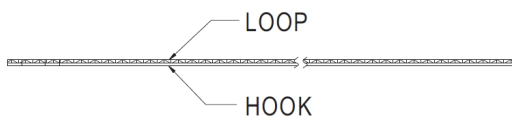
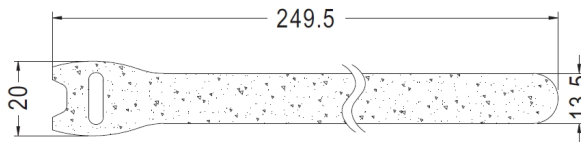

PART NO	PACKAGE
VELCRO-4	500

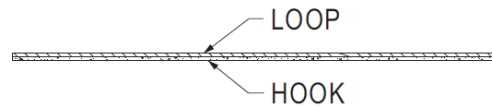
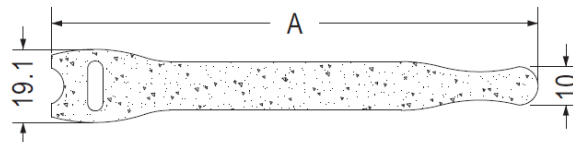

PART NO	A	PACKAGE
VELCRO-5	127.0	500
VELCRO-7	155.0	500

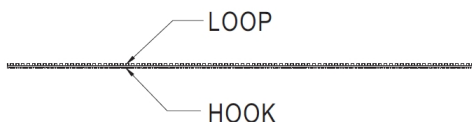
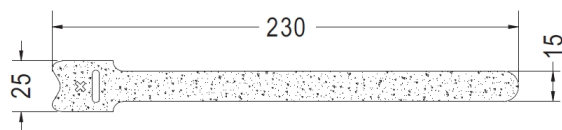

PART NO	PACKAGE
VELCRO-6	500



# 电子电脑塑胶五金零件目录

1.LED间隔柱

2.LED导光柱 LED导光盖 LED遮光罩

3.LED座 LED座套 红外线灯罩 光纤座

4.90°LED灯座 45°LED灯座

5. PC板间隔柱 PC板隔离柱

6. 塑料铜柱 尼龙柱 六角隔离柱 塑胶铜柱 铜柱 导光板隔离柱 圆体间隔柱 PC板固定定座 固定扣 电路板隔离柱 导电隔离柱

7. 排线固定座 自粘式配线固定座 排线固定夹 压线板 电线固定座 扭线固定座 扭式固定环 扎线固定座 电源线固定座 电源线固定座插头固定扣 天线固定座 T8灯管固定座 风扇束线座 光纤固定座

8. PC板端子 接线插片端子 PC板焊接端子 接地片 圆形连接片 弹片 测试针 探针 测试点 保险丝座 保险丝盖 插式电线连接头 闭端端子 弹簧螺纹端子 压线帽 端子台 快速接线夹 跳线

9. 仪表脚垫 插销式脚垫 螺丝固定脚垫 脚垫 抗震脚垫 磁铁脚垫 橡胶脚垫 自粘脚垫 银框脚垫 金框脚垫 橡胶垫圈 橡胶华司 橡胶垫片 硅胶脚垫

10. 塑料螺丝 塑胶螺丝 翼型塑料螺丝 塑料螺帽 塑料螺帽 蝶形螺母 止付螺丝 紧定螺钉 内牙螺丝 螺丝帽盖 手转螺丝 手拧螺丝 滚花螺丝 手转螺母 手拧螺母

11. PC板拉柄 PC板耳把 PC板导槽 电路板导轨 PCB导轨槽 直立式导槽 电路板导轨

12. 晶体管盖 电晶体盖 晶体管垫片 电晶体垫片 晶体管座 电晶体座 T-O3晶体管座 石英晶体垫片 垫圈 华司 垫片 TO-220晶体管座 光电晶体座 电晶体座 IR晶体座 霍尔晶体座 硅胶帽套 功率晶体导热硅片 功率晶体压板 电源固定压条 晶体管固定弹片 五金弹片 电晶体固定弹片 晶体管夹

# 电子电脑塑胶五金零件目录

13.电容器垫片 垫圈 华司 电容器座 电容器帽套 电容器固定座 电容器盖 电容器护套 压敏护套 硅胶帽套

14.热敏电阻座 电阻保护座 保护电阻器 可变电阻盖

15.陶瓷零件垫片 零件垫片 垫圈 华司 零件垫座 IC座 桥式整流座 跳线座 线圈座 滤波器垫片 绝缘柱 螺丝垫片 滚轮 PC板垫片 球击缓冲垫片 尼龙垫圈 尼龙弹簧垫片 散热陶瓷垫片

16.功率IC盖 桥式整流盖 保护盖 开关盖 硅胶盖 绝缘盖 电池盖 末端套管 软质端子保护套PC端子保护套 喇叭座 拉柄箱扣 线圈固定座 DRAM固定带 十字型插件式固定器 轨道固定器

17.孔塞 扣式孔塞 扣式塞头 DVI防尘盖 螺丝孔孔塞 螺丝塞头 螺纹孔塞

18.电源线扣 电线固定夹 护线环 橡胶圈 护线圈 开口式护线环 橡胶线环 硅胶线环 硅胶护线环 天线护线环 方型护线环 U型护线环 抗震护线环 防震线环 抗震线环用插销 抗震线环用螺丝 硬盘驱动器防震座 透气压力平衡固定头 透气平衡压力固定扣

19.把手 机箱把手 仪器门拉手 纸箱把手 纸箱配件 打包扣 外箱护脚垫 纸箱外箱扣

20.阻尼齿轮 阻尼器 缓冲齿轮

21.电线扎带 电线束线带 固定带 扎线 电源线收线带 珠型扎带 水管座 扎带座 扎带扣 吊勾粘扣带 绑线带

22.USB座护盖 USB端口保护盖 USB端口防尘盖 MICRO USB防尘盖 MINI USB座护盖USB Type-C防尘盖 USB防尘盖 RJ-45防尘盖 RJ-11防尘盖 RJ-12防尘盖 RJ-22防尘盖 电源插头防尘盖 电源插头保护座 电源插头防尘座 电源插头防尘盖 光纤连接器护盖 光纤连接器护套 光纤防尘盖 PC板金手指防尘盖 HDMI防尘盖 Mini数位端子防尘盖 汽车点烟器防尘盖BBU防尘盖 DVI防尘盖 连接器盖 SIM Card Cap防尘盖 SD防尘盖 KVM防尘盖 CF防尘盖 防尘盖 端子盖 S端子盖 平衡端子盖 BNC绝缘座 SATA防尘盖 ESATA护盖 DP端子防尘盖 Mini D.P数位端子防尘盖 D.Type防尘盖 VGA防尘盖 IDE Connector防尘盖 PC端子防尘盖 端子防尘盖 1394端子防尘盖 零件盖 电源盖 机板电源保护盖 连接器座 PCMIC卡保护盖 面板 DDR防尘盖 D-Sub保护盖 高压防尘盖 SD保护盖 Micoro SD卡保护盖 SIM卡保护盖 防水帽盖 帽盖连接带 防水圈 电脑风扇防护盖 电脑风扇防尘座 电脑风扇框护垫 电脑风扇支架 开关遮板 光纤晶体座

# 电子电脑塑胶五金零件目录

23.插销 铆钉 尼龙铆钉 螺丝铆钉 散热片铆钉 塑料铆钉 电脑风扇铆钉 散热片扣件 弹簧铆钉 螺丝固定座 膨胀螺栓 墙塞 无帽鱼型膨胀管 墙面固定座 石膏板固定座

24.固定扣 门扣开关 机器门扣开关 弹簧固定座 旋转型门扣 门扣碰珠 磁铁门扣

55.工具 线扣工具 进口束线枪 旗型端子工具 国产束线枪 非绝缘端子工具 绝缘端子工具



# 电子电脑塑胶五金零件目录



1.LED间隔柱



2.LED导光柱



3.LED座



4.90°LED灯座



5.PC板间隔柱



6.塑料铜柱



7.排线固定座



8.PC板端子



9.仪表脚垫



10.塑料螺丝



11.PC板拉柄导槽



12.晶体管盖



13.电容器垫片



14.热敏电阻座



15.陶瓷零件垫片



16.功率IC盖



# 电子电脑塑胶五金零件目录



17.孔塞



18.电源线扣



19.机箱把手



20.阻尼齿轮



21.电线扎带



22.USB座护盖

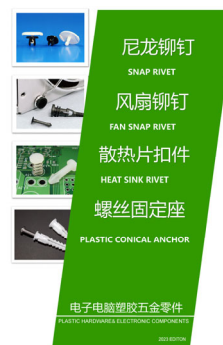

23.尼龙铆钉



24.门扣开关



55.工具

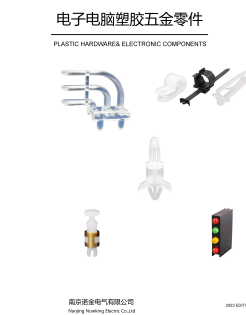

选型手册总目录

本公司保留因质量改进、后续开发或生产要求引起的设计更改权力。本产品目录为元件的详细说明，不能做担保依据。使用者有义务审核该元件是否符合应用范围的规定。





微信



QQ

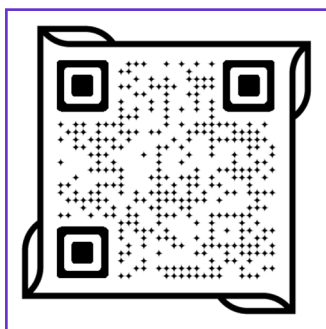

网站

## 南京诺金电气有限公司

Nanjing Nowking Electric Co., Ltd

- ◆ Tel: 025-85422485 85436028 85437901
- ◆ Wechat/Mobile :13770725488
- ◆ QQ:260678075
- ◆ E-mail: nk@nowking.com
- ◆ [Http://www.nowking.com](http://www.nowking.com)
- ◆ [Http://www.kyphe.com](http://www.kyphe.com)